

NOISE FILTER

1Ø 250V 보급형 General Type



UL 인증



● Features

- 2 Mounting Option
 - WYF****D : Din Rail Mounting
 - WYF**** : Screw Mounting
- Wide Band : High Attenuation
- Band Width : 150KHz ~ 30MHz
- Low Leakage
- RoHS Compliant
- KC(안전인증)
- Approved by HH03009-10002C
- UL(규격인증)

● Specifications

ITEM	MODEL	SYMBOL	WYFS06T1A(D)	WYFS10T1A(D)	WYFS15T1A(D)	WYFS20T1A(D)	WYFS30T1A(D)
Rated Voltage	V		250				
Rated Current	A		6	10	15	20	30
Frequency	Hz		50 / 60				
Dielectric Withstand	V		1500VAC or 2250VDC for 1 minute(Line-Case)				
Insulation Resistance	MΩ		300				
Leakage Current	mA		≤2.5mA at the 250Vac				
Operating Temperature	°C		-25°C ~ +100°C [Refer to Derating Curve TYPE-1]				
Operating Humidity	RH		35 ~ 85%RH				
Weight	kg		0.3				

※ Derating Curve of page 519

● Circuit Diagram

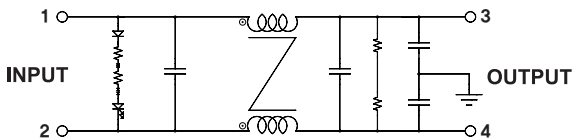

● Terminal

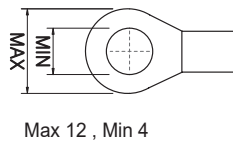

● Characteristics

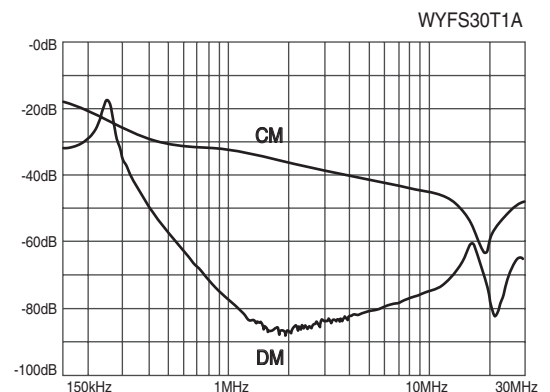
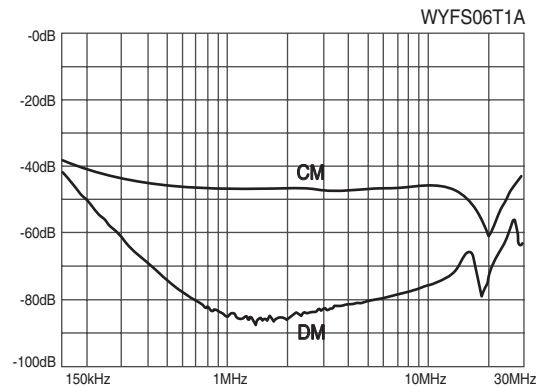

● Dimension

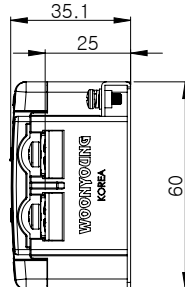
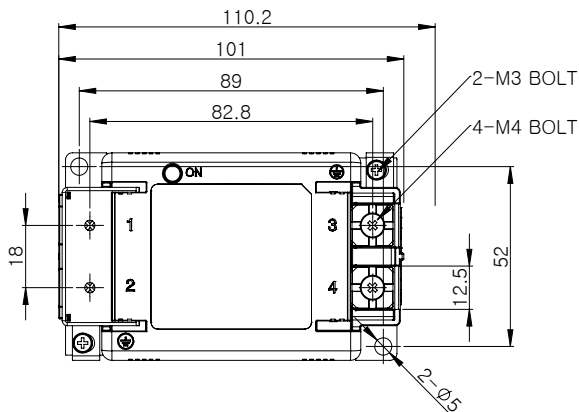

트랜스포머
REACTOR
리액터
무정전압 레이어
SSR
전력조정기
TPR
스위칭파워
SMP
노이즈 필터
H/F
하모닉 필터
S/P
서지보호기
RELAY
보통계전기
E/LD=GF
누전경보기
ZCT
영상변류기
METER
판넬메타
CT=VT
계기용변성기
SHUNT=FA
센트팬

NOISE FILTER

1Ø 250V Characteristics

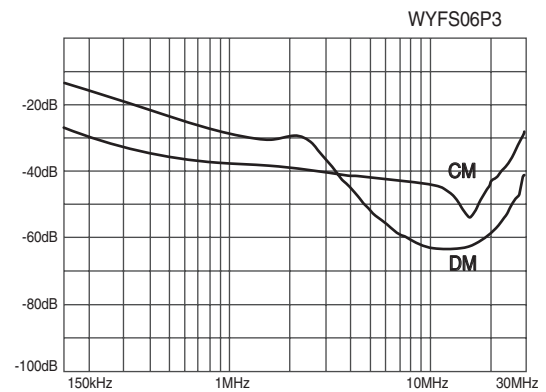
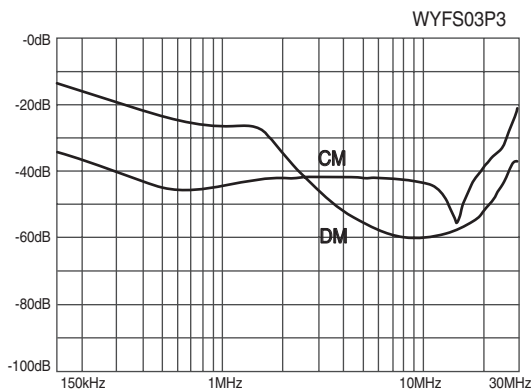
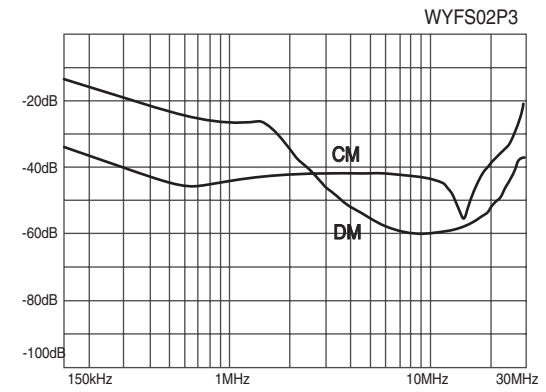
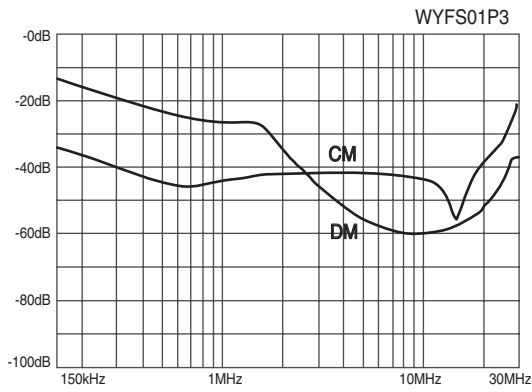
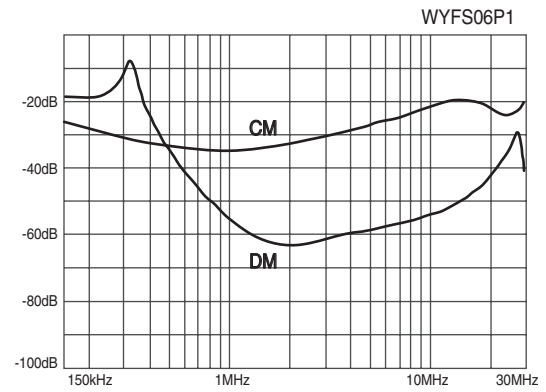
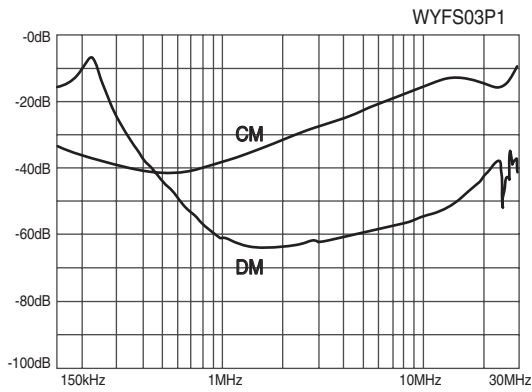
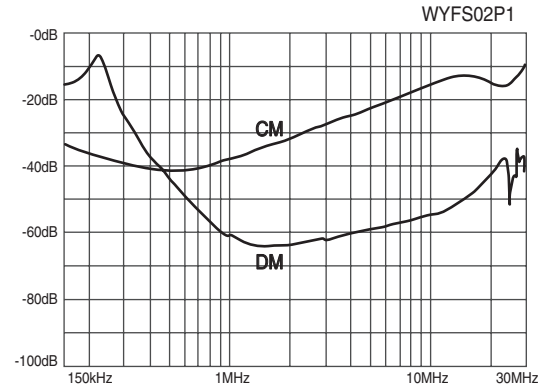
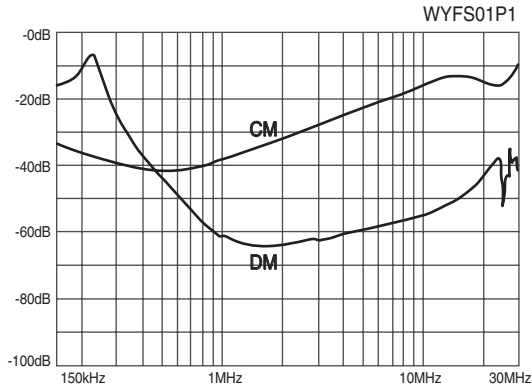

※ CM : Common mode, DM : Differential mode

트랜스포머
REACTOR
리액터
무정전압 레일
SSR
전력조정기
TPR
스위칭파워
SMP
S
노이즈 필터
H/F
하모닉 필터
SPD
서지보호기
RELAY
보호계전기
E/D=GF
R
영상변류기
ZCT
METER
판넬메타
계기용변성기
CT=VT
S
선편팬
SHUNT=FAN

● Characteristics

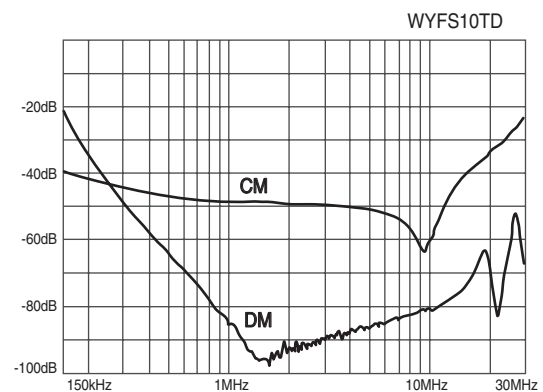
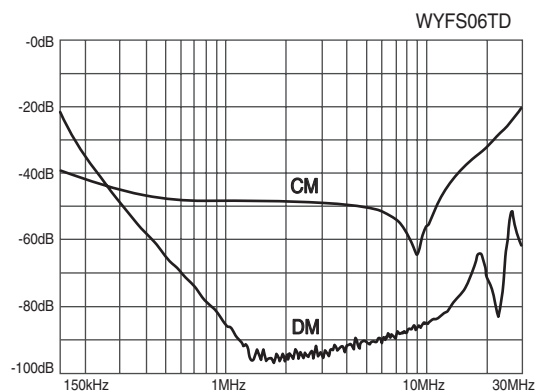
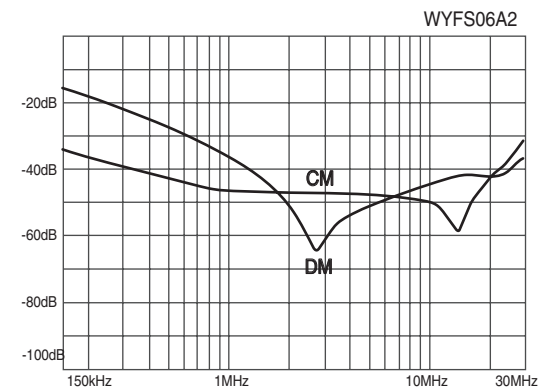
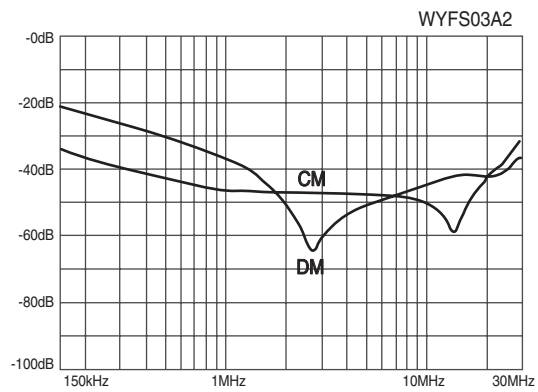
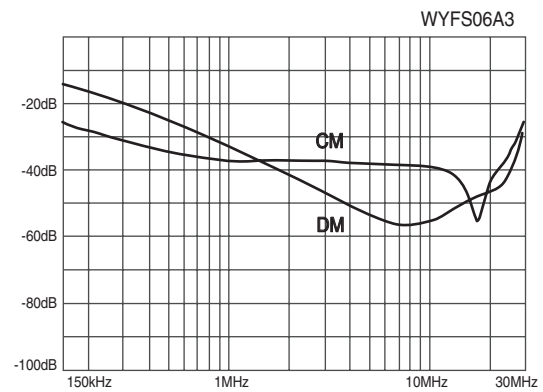
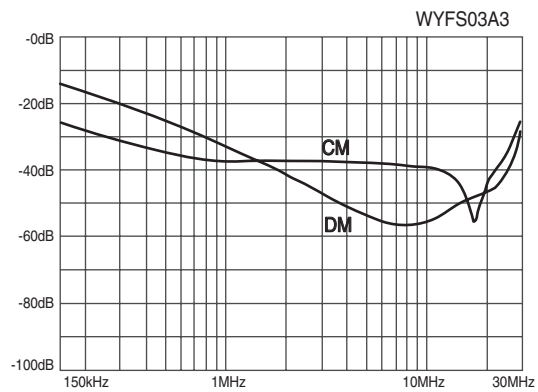
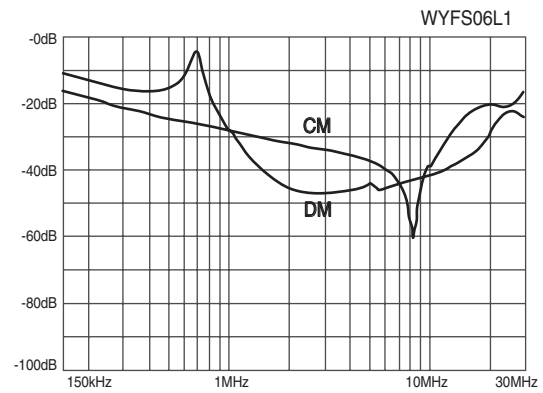
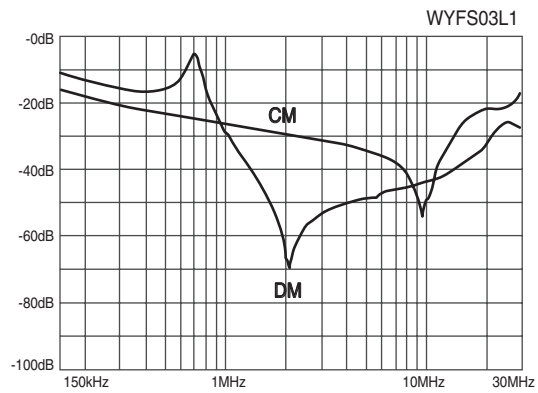

※ CM : Common mode, DM : Differential mode

● Characteristics

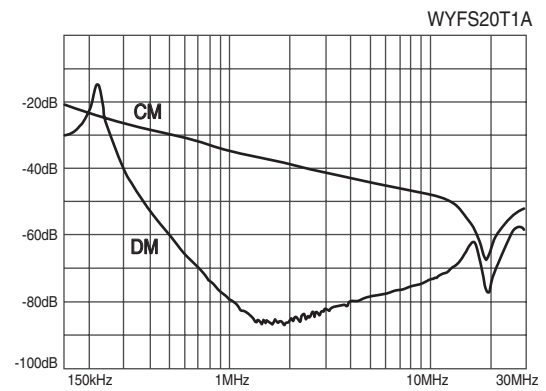
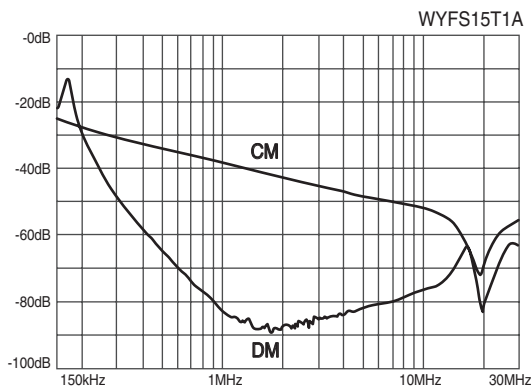
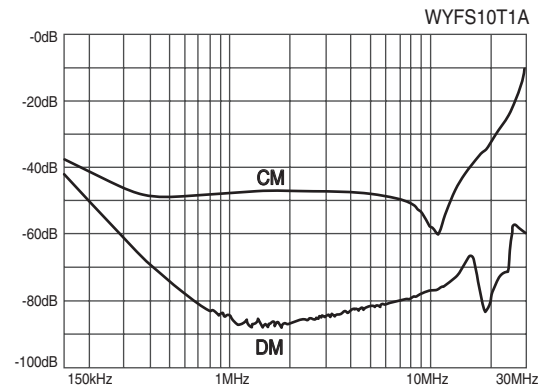
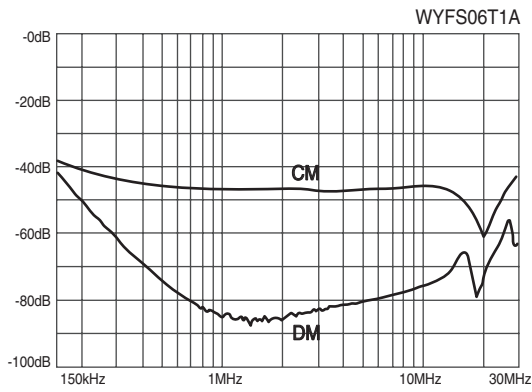
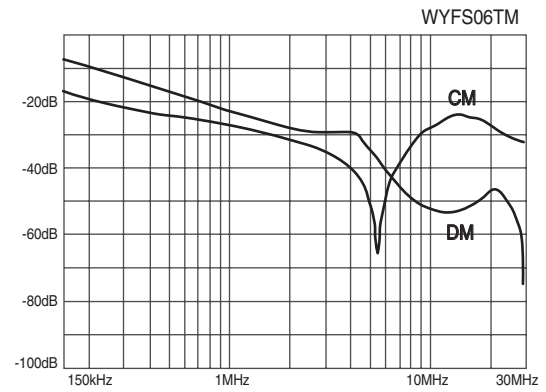
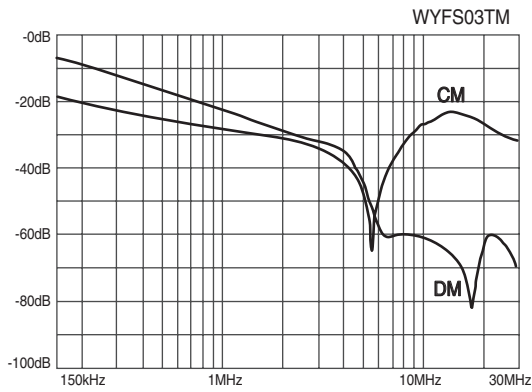
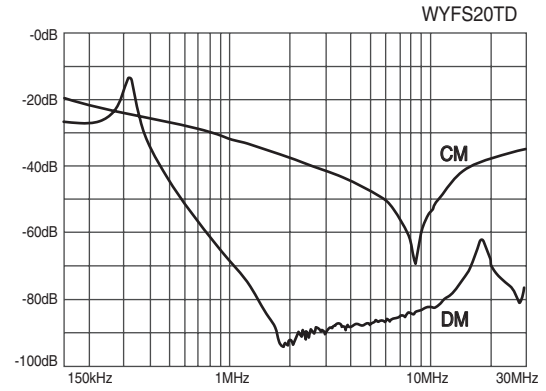
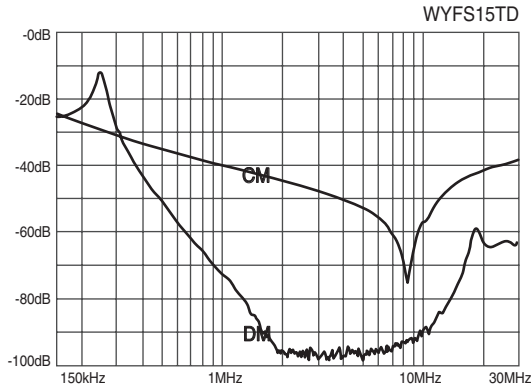

※ CM : Common mode, DM : Differential mode

TRANS= NCT 트랜스포머
 REACTOR 리액터
 SSR 무정전압블레이
 TPR 전력조정기
 SPS 스위칭파워
 NF 노이즈필터
 HF 하모닉필터
 SPD 서지보호기
 RELAY 보호계전기
 ELD= GFR 누전경보기
 ZCT 영상변류기
 METER 판넬메타
 CT= VT 계기용변성기
 SHUNT= FAN 션트팬

● Characteristics

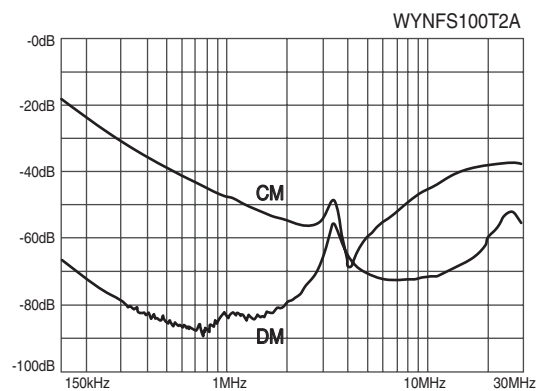
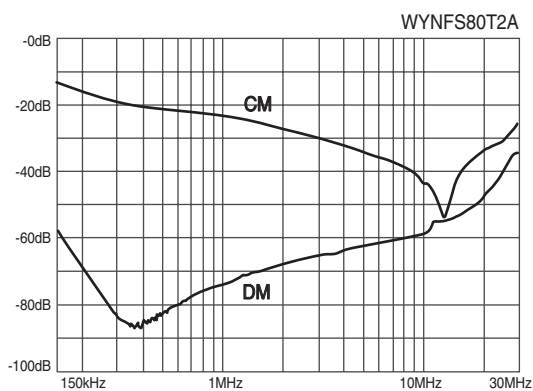
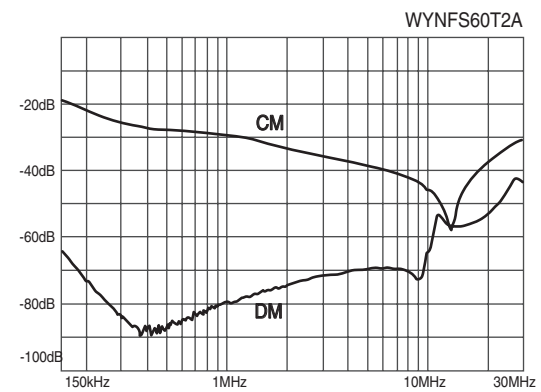
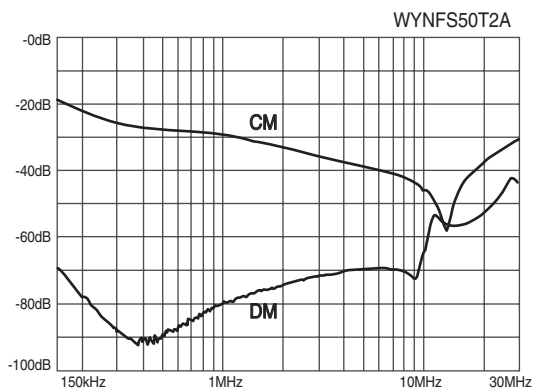
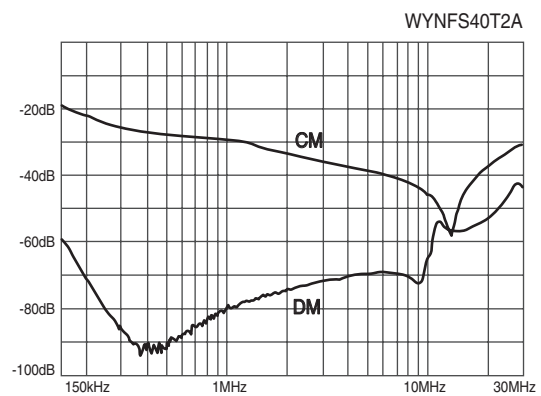
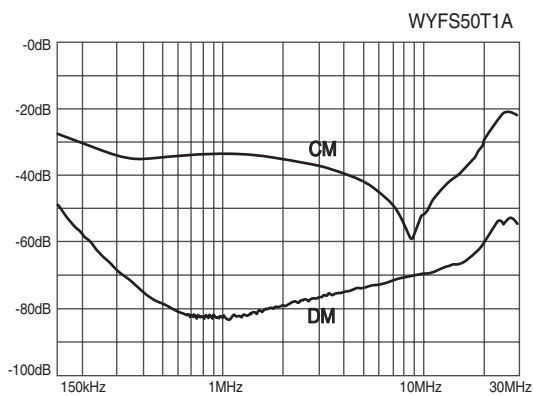
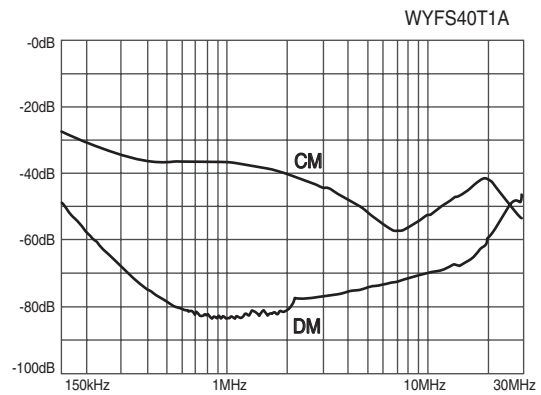
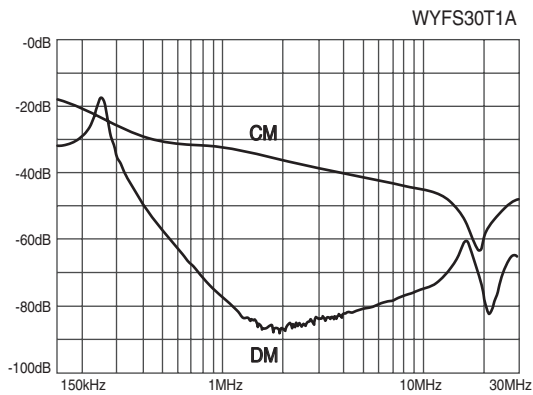

※ CM : Common mode, DM : Differential mode

● Characteristics

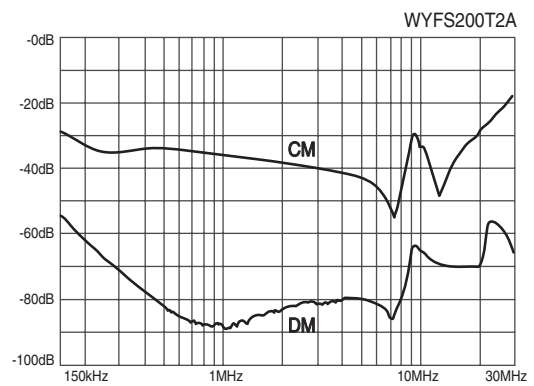
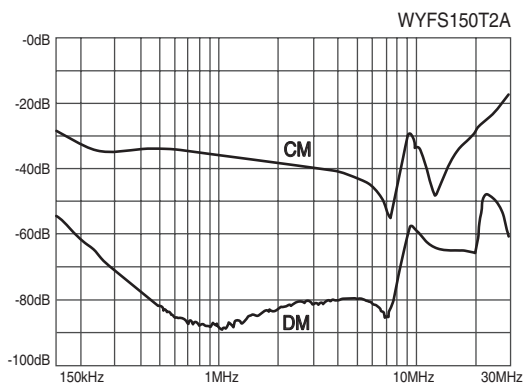
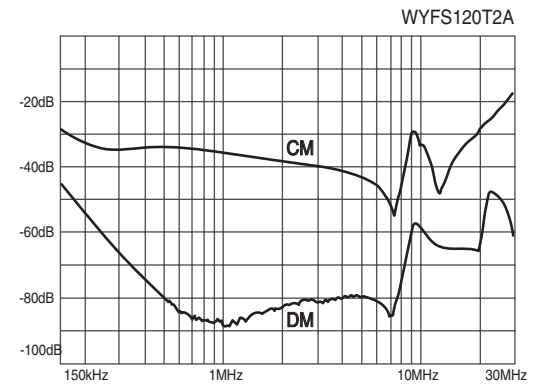
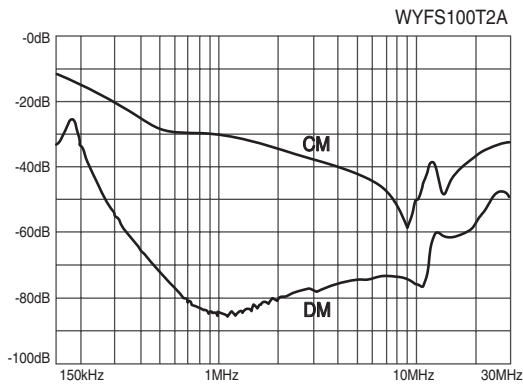
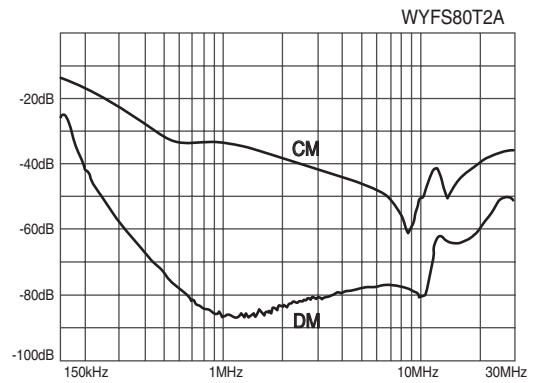
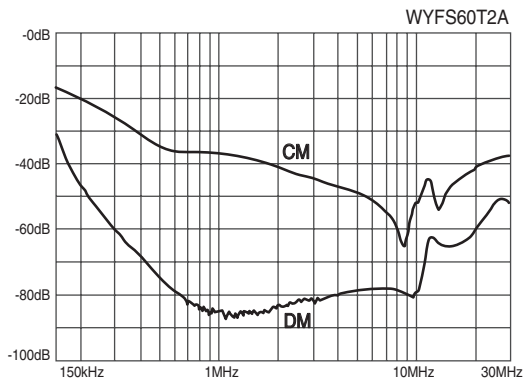
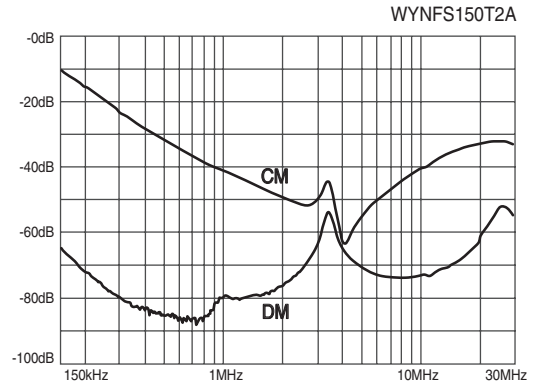
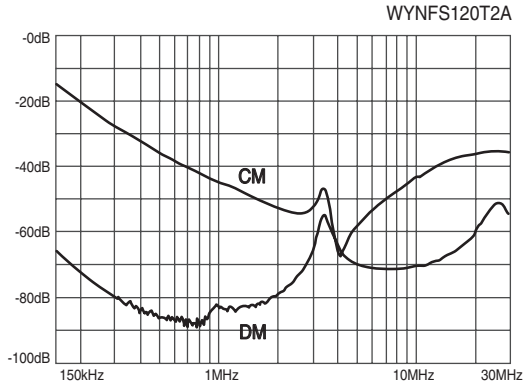

※ CM : Common mode, DM : Differential mode

트랜스포머
REACTOR
리액터
무정전압블레이
SSR
전력조정기
TPR
스위칭파워
SMPSS
노이즈 필터
NF/F
하모닉 필터
H/F
서지보호기
SPD
보호계전기
RELAY
누전경보기
ELD=GFRR
영상변류기
ZCT
판넬메타
METER
계기용변성기
CT=VT
SHUNT=FAAN

● Characteristics

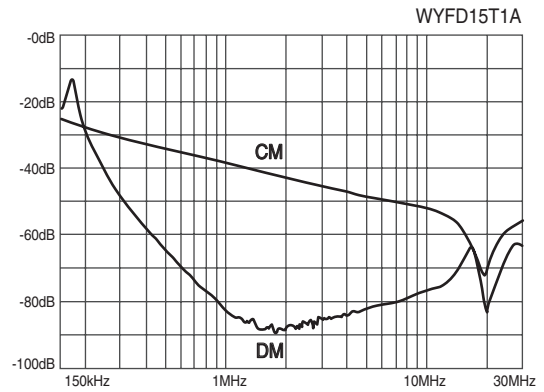
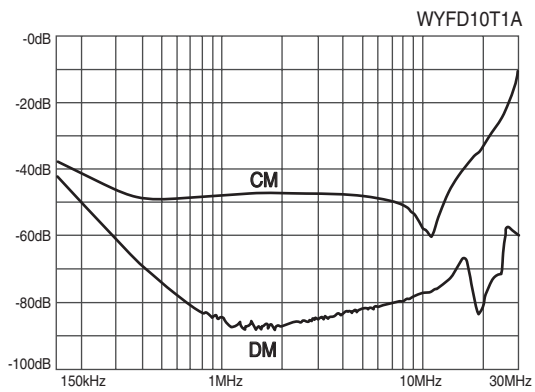
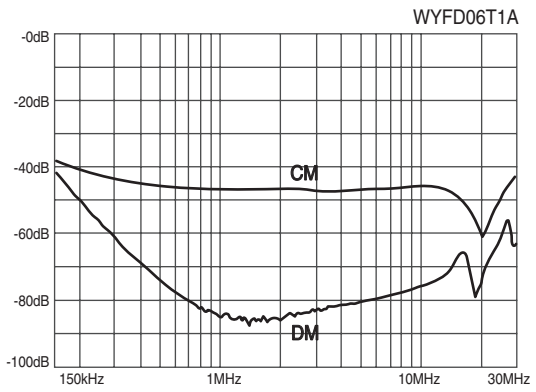
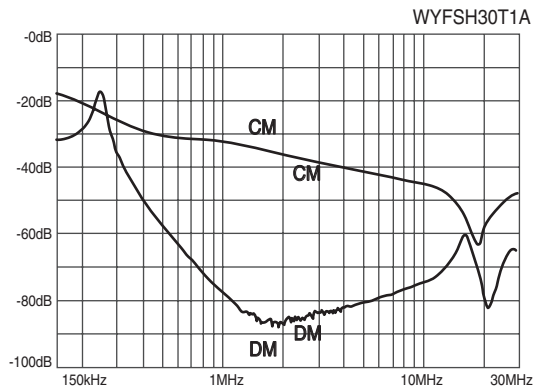
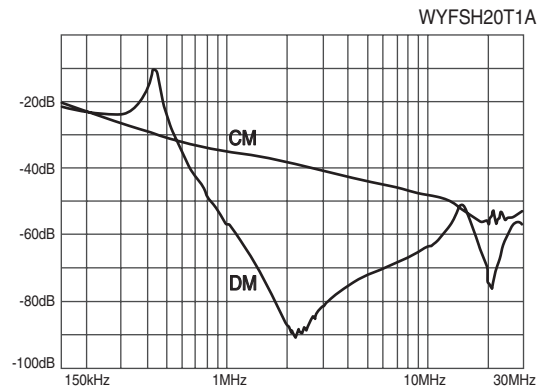
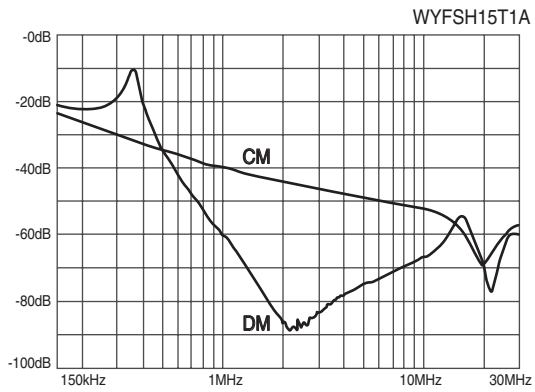
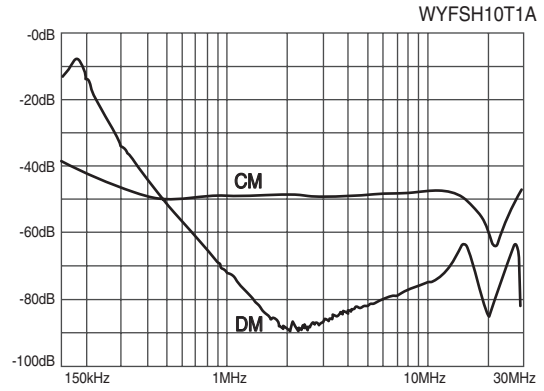
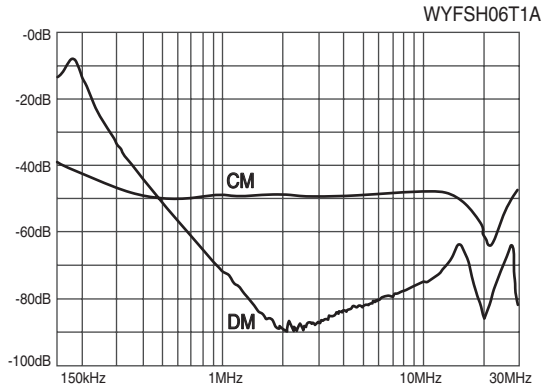

※ CM : Common mode, DM : Differential mode

● Characteristics

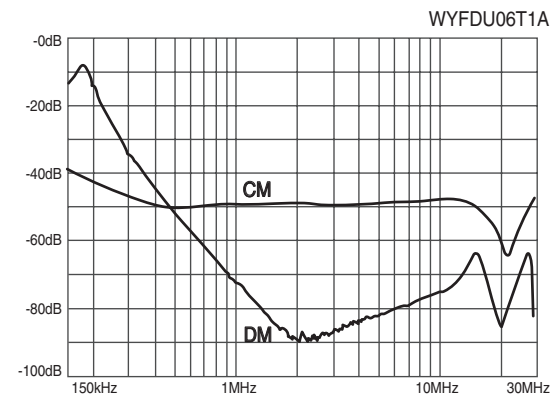
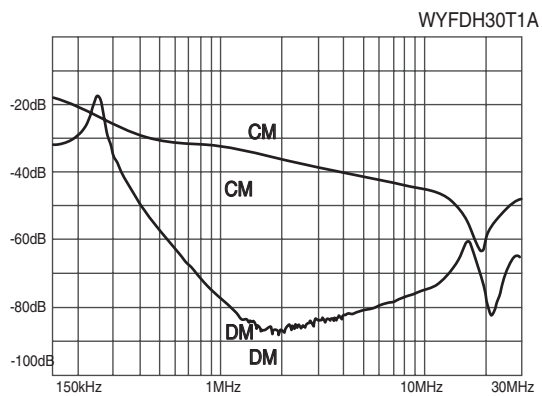
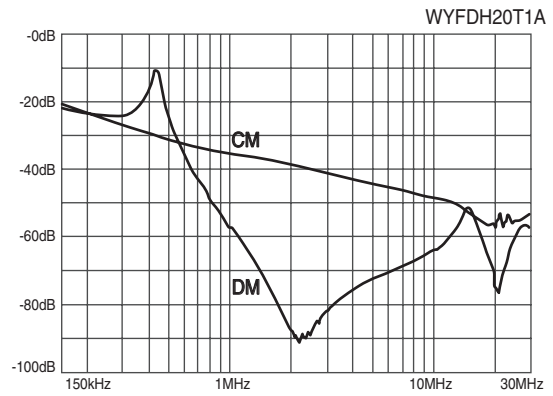
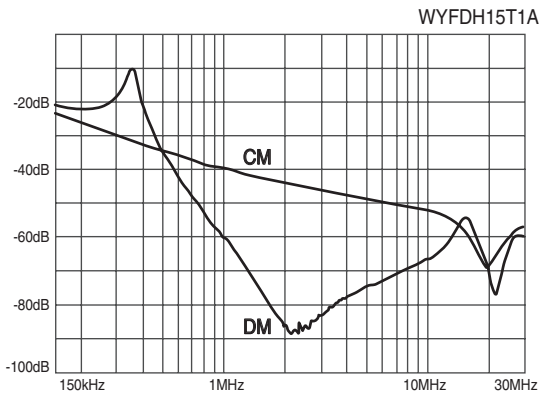
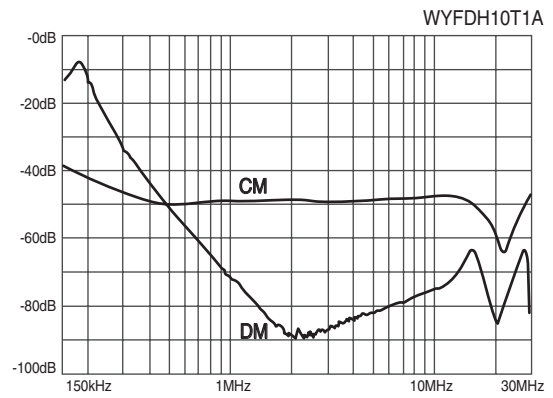
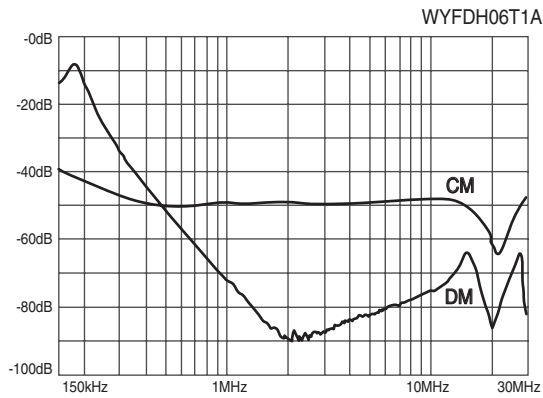
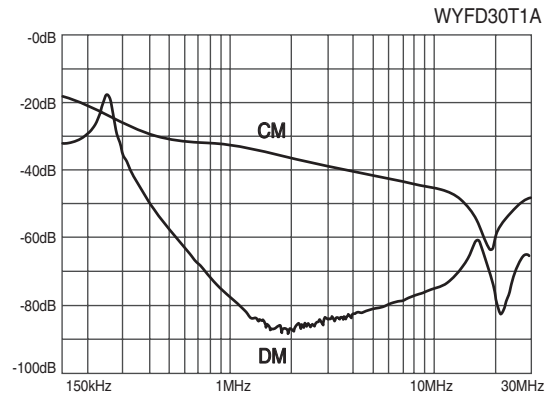
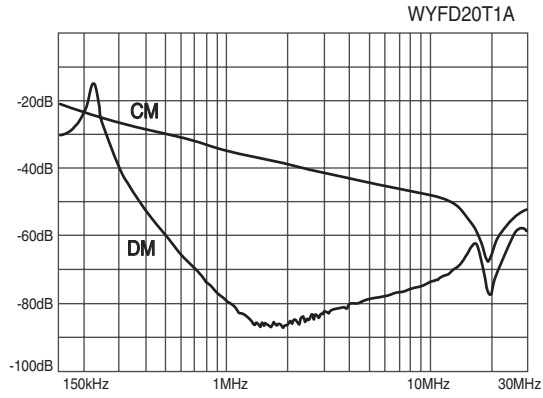

트랜스포머
REACTOR
리액터
무정전압블레이
SSR
전력조정기
TPR
스위칭파워
SMPSS
노이즈 필터
N/F
하모닉 필터
H/F
서지보호기
SPD
보호계전기
RELAY
누전경보기
ELD=GFR
영상변류기
ZCT
판넬메타
METER
계기용변성기
CT=VT
선트랜팬
SHUNT=FAN

● Characteristics

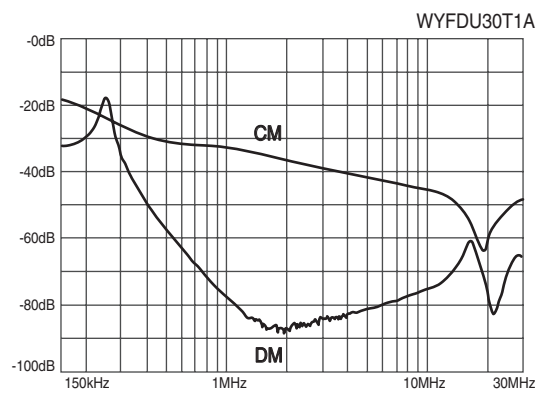
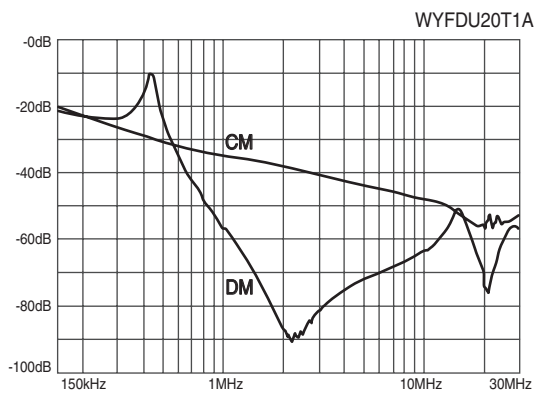
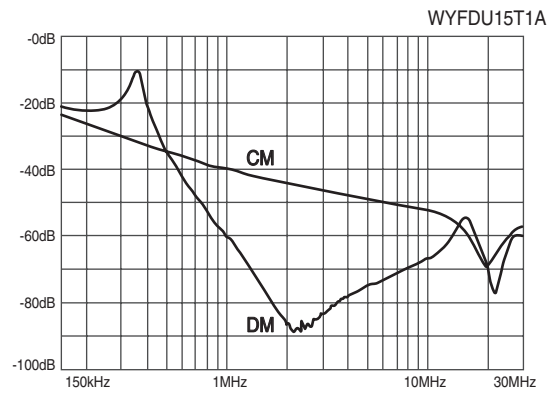
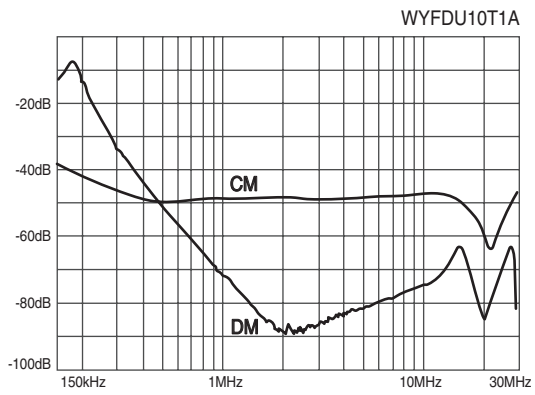

※ CM : Common mode, DM : Differential mode