

NOISE FILTER

1Ø 250V 고급형 High Quality Type

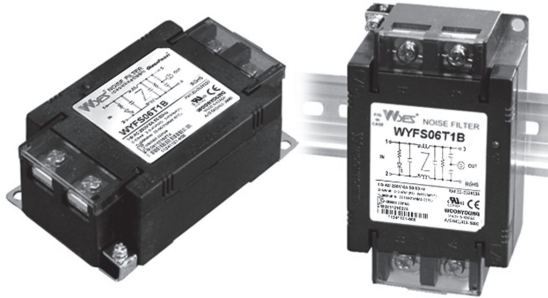

UL 인증



● Features

- 2 Mounting Option
 - WYF****D : Din Rail Mounting
 - WYF**** : Screw Mounting
- Wide Band : High Attenuation
- Band Width : 150KHz ~ 30MHz
- Low Leakage
- RoHS Compliant
- KC(안전인증)
- Approved by HH03009-10002C

● Specifications

ITEM	MODEL	SYMBOL	WYFS06T1B (D)	WYFS10T1B (D)	WYFS15T1B (D)	WYFS20T1B (D)	WYFS30T1B (D)
Rated Voltage	V		250				
Rated Current	A		6	10	15	20	30
Frequency	Hz		50 / 60				
Dielectric Withstand	V		1500VAC or 2250VDC for 1 minute(Line-Case)				
Insulation Resistance	MΩ		500				
Leakage Current	mA		0.8				
Operating Temperature	°C		-25°C ~ +100°C [Refer to Derating Curve TYPE-1]				
Operating Humidity	RH		35 ~ 85%RH				
Weight	kg		0.3				

※ Derating Curve of page 519

● Circuit Diagram

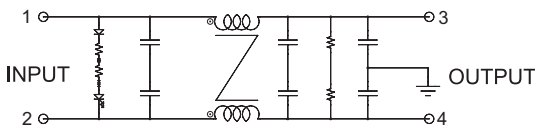

● Terminal

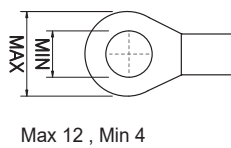

● Characteristics

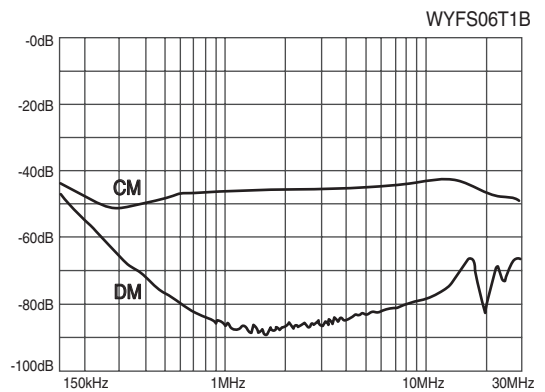

● Dimension

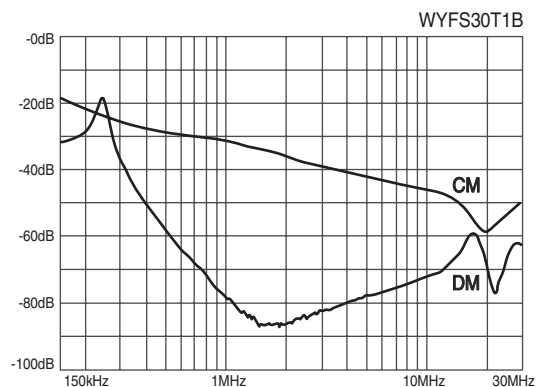
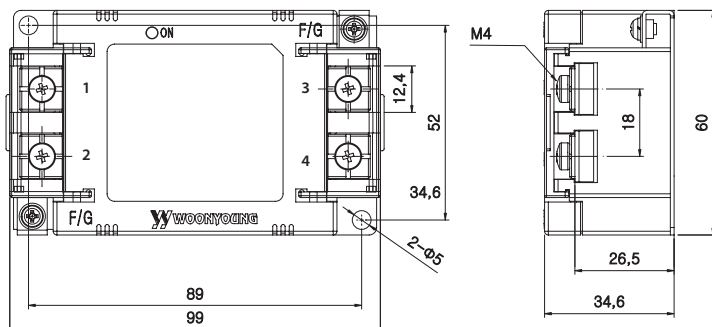

● Characteristics

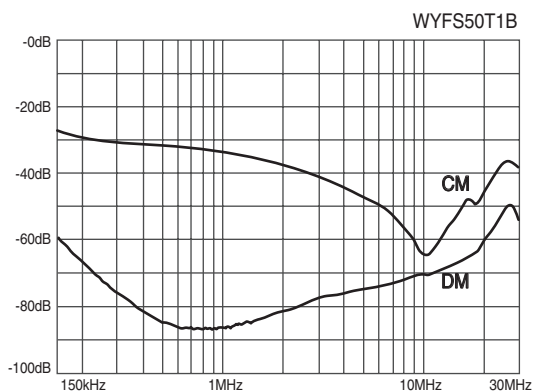
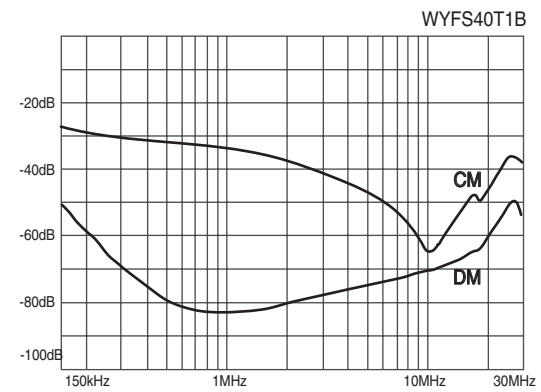
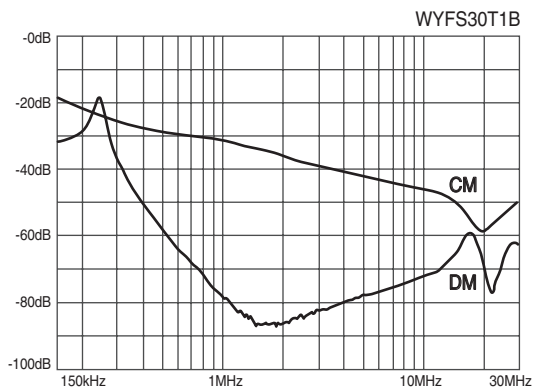
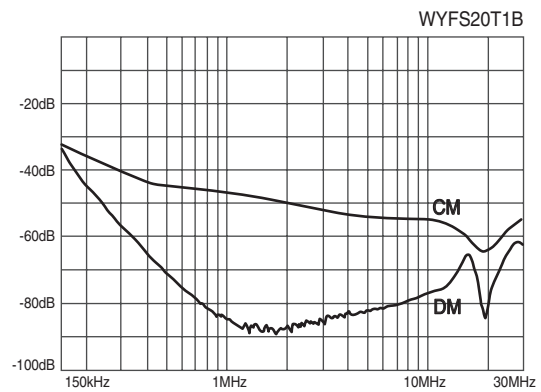
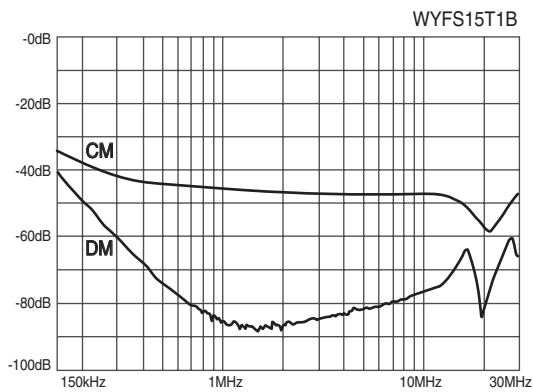
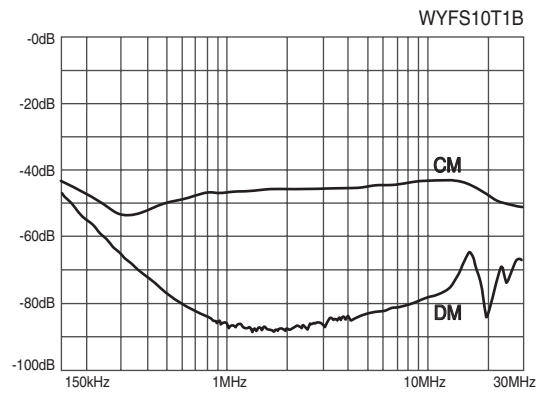
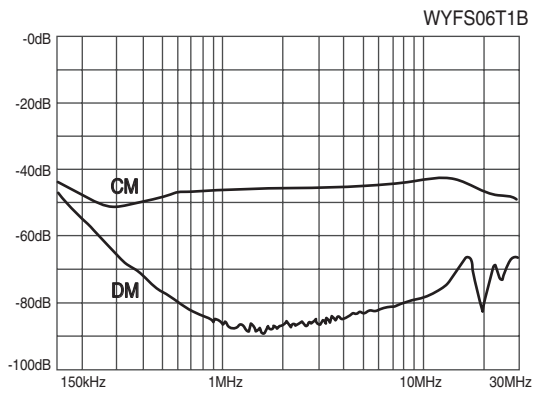

※ CM : Common mode, DM : Differential mode